

Instruction Manual

765 Laboratory pH Meter



Knick >
Elektronische Meßgeräte
GmbH & Co.
P.O.Box 37 04 15
D-14134 Berlin
Germany

Tel: +49 (0) 30-80191-0
Fax: +49 (0) 30-80191-200
www.knick.de
knick@knick.de



Warranty

Defects occurring within 3 years from delivery date shall be remedied free of charge at our works (carriage and insurance paid by sender).
Accessories: 1 year

Subject to change without notice

Contents

Information on this instruction manual	II
Safety information	III
EC Declaration of Conformity	IV
1 The 765 Laboratory pH Meter	
Package contents	1
Short device description	1
2 Operation	2
Meter design	2
General information	3
Power-on and start-up	6
Parameter level	10
Calibration level	18
Diagnostics level	21
Trueline [®] recorder output	30
Serial interface	31
Standard settings for ZU 0244 Lab Printer	32
Command set for the serial interface	32
3 Troubleshooting	41
Error messages	41
Appendix	45
Product line	45
Specifications	46
Buffer tables	49
Glossary	55
Index	59

Information on this instruction manual

Warnings and notes



Instructions marked with this sign must be strictly observed for reasons of your own safety! Failure to follow these instructions may result in injuries.

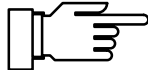

Notes provide important information that should be strictly followed when using the device.

Typical representations

PAR VIEW
ERR --PH--

Display example

A gray representation of the display text indicates a flashing display.

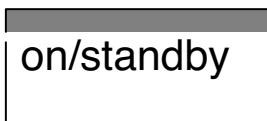

Keys whose functions are described.

Markings in the text

Keys are represented by **bold-faced** text, e.g. **meas**, **print**, **▲**, **▶**, **▼**, **,**, **...**, **enter**.

Safety information

Be sure to read and observe the following instructions!

Before connecting the device to the power supply, make sure that the voltage corresponds with the rating given on the rating plate of the device.

Opening the device exposes live parts. Therefore, it shall not be opened. If a repair should be required, return the device to our factory.

If opening the device is inevitable, it shall first be disconnected from all voltage sources. Make sure that the mains supply has been disconnected.

Repair or adjustment of an opened device under voltage shall be carried out only by a skilled person who is aware of the hazards involved.

Remember that the voltage across accessible parts of the open device may be dangerous to life.

Whenever it is likely that the protection has been impaired, the device shall be made inoperative and secured against unintended operation.

The protection is likely to be impaired if, for example:

- the device shows visible damage
- the device fails to perform the intended measurements
- after prolonged storage at temperatures above 70°C
- after severe transport stresses

Before recommissioning the device, a professional routine test in accordance with EN 61010-1 must be performed. This test should be carried out at our factory.

Knick >Knick
Elektronische Messgeräte
GmbH & Co. KG
Beuckestr. 22
D-14163 Berlin**EG-Konformitätserklärung
EC Declaration of Conformity
Déclaration de Conformité CE**Dokument-Nr. / Document No. /
No. document**EG90817A**Aufbewahrung / Keeping / Garde en dépôt
Jürgen Cammin (KB)

Wir, die / We, / Nous,

**Knick Elektronische Messgeräte GmbH & Co. KG
Beuckestr. 22, D-14163 Berlin**erklären in alleiniger Verantwortung, daß dieses Produkt / diese Produkte,
declare under our sole responsibility that the product / products,
déclarons sous notre seule responsabilité que le produit / les produits,Produktbezeichnung /
Product identification /
Désignation du produit**Labor-pH-Meter 765, Opt. ...**auf welche(s) sich diese Erklärung bezieht, mit allen wesentlichen Anforderungen der folgenden Richtlinien des Rates übereinstimmen:
to which this declaration relates is/are in conformity with all essential requirements of the Council Directives relating to:
auquel/auxquels se réfère cette déclaration est/sont conforme(s) aux exigences essentielles de la Directives du Conseil relatives à:Niederspannungs-Richtlinie /
Low-voltage directive /
Directive basse tension**2006/95/EG**Jahr der Anbringung der CE-Kennzeichnung / **1995**
Year in which the CE marking was affixed /
L'année d'apposition du marquage CEHarmonisierte Normen / Harmonised
Standards / Normes harmonisées**EN 61010-1: 2001**EMV-Richtlinie / EMC directive /
Directive CEM**2004/108/EG**

Norm / Standard / Norme

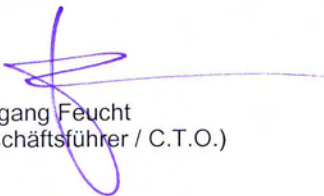
**EN 61326-1: 2006
EN 61326-2-3: 2006**Ausstellungsort, -datum /
Place and date of issue /
Lieu et date d'émission**Berlin, 17.08.2009****Knick Elektronische Messgeräte GmbH & Co. KG**
Wolfgang Feucht
(Geschäftsführer / C.T.O.)
ppa.
Bernhard Kusig
(Vice President Marketing/Sales)

The 765 Laboratory pH Meter

Package contents

After unpacking, please check the shipment for completeness. The package should contain:

- 765 Laboratory pH Meter
- Power cord
- This instruction manual

Short device description

- The Model 765 is used for pH and ORP measurements in the laboratory.
- Temperature compensation is automatic using a Pt 100 or Pt 1000 temperature probe or manual by entering the temperature.
- Buffer solutions of eleven different, selectable buffer sets are provided for calibration. Buffer recognition is automatic via Calimatic[®].
- The calibration timer alerts you when the preset interval between two calibrations has expired.
- Sensoface[®] electrode monitoring checks the connected electrode and provides information on the electrode condition.
- Knick Fullcheck[®] device self-test checks the device functions at the press of a key.
- Records of parameter setting, calibration and diagnostics are particularly helpful for QM documentation to ISO 9000 and GLP. The records can be directly output to a standard printer via the integrated serial interface.

2 Operation

Meter design

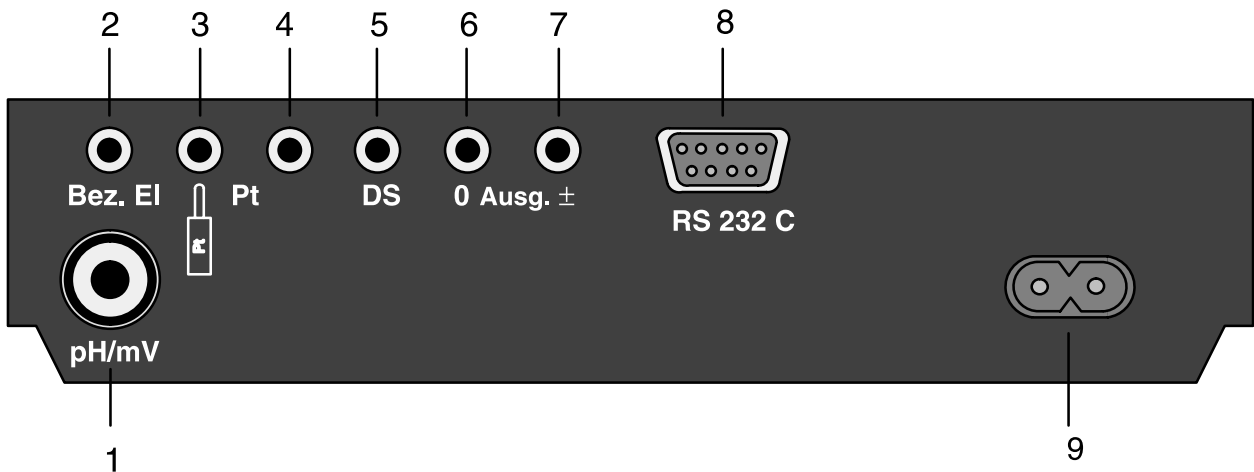
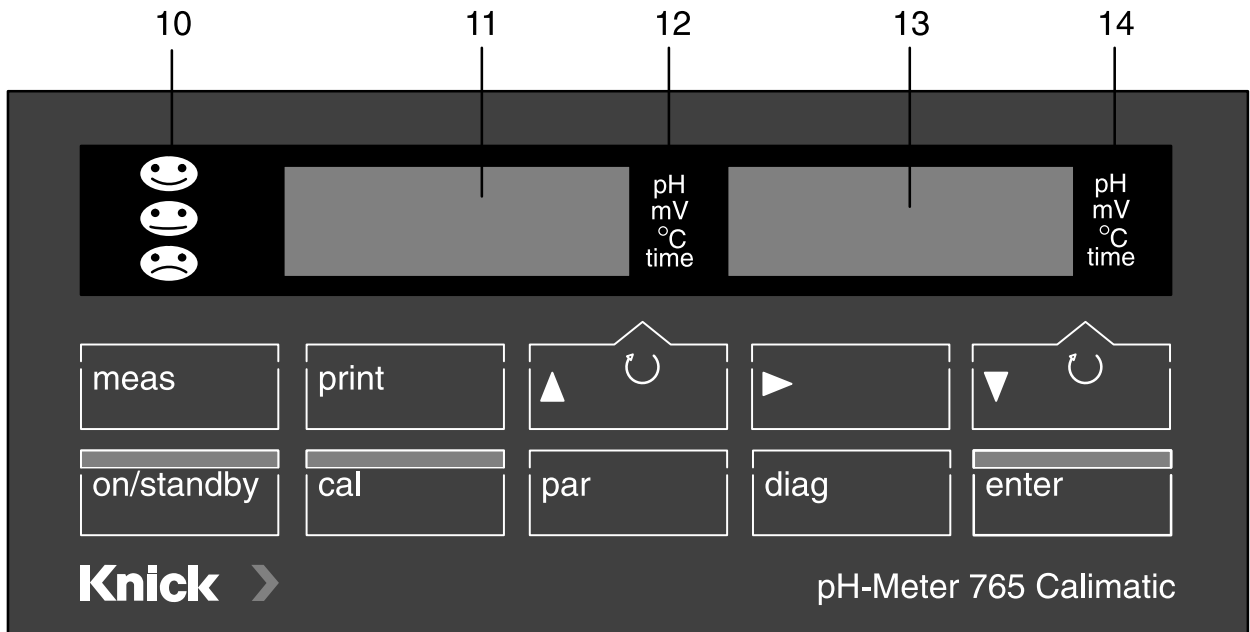

- 1, 2 Electrode connection
- 3, 4 Temperature probe connection
- 5 DS connection
- 6, 7 Recorder output
- 8 Interface connection
- 9 Power input
- 10 Sensoface[®] display
- 11, 13 Displays
- 12, 14 Measurement symbols

General information

Keypad



Pressing **on/standby** turns the pH meter on or switches to standby mode. Standby mode is indicated by a lighted Sensoface[®] status display or two measurement symbols. At power-on, the pH meter automatically performs a short self test and then goes to measuring mode.

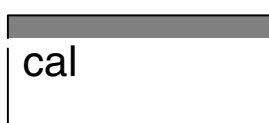

Pressing **cal** opens the Calibration level. On the Calibration level the pH meter is adapted to the electrode. You can conduct either a one or a two-point calibration.



Pressing **par** opens the Parameter level. On the Parameter level all variable device parameters are set.

- In the VIEW menu you can view all parameters.
- In the EDIT menu you can also edit the parameters.



Pressing **diag** opens the Diagnostics level. On the Diagnostics level you can get information on the electrode condition, view the current electrode data, and perform a complete device self test.

- The Sensoface[®] menu lists the individual parameters of Sensoface[®] automatic electrode monitoring with the corresponding evaluations.
- The Electrode Data menu shows the values for zero and slope of the electrode determined during last calibration, the remaining time until the next due calibration determined by the calibration timer and the data of the electrode statistics.
- With the Knick Fullcheck[®] menu, a complete device self-test is performed.

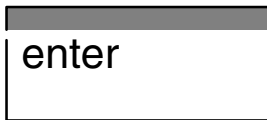

Pressing **enter** stores an entered parameter. If you have not made any changes, pressing **enter** selects the next parameter (instead of ▼).



Pressing **meas** exits a function level and returns you to measuring mode.



Pressing **print** in measuring mode prints out the current pH, mV and temperature values with date and time. Pressing **print** on one of the function levels prints out a complete record of the data stored.

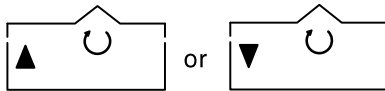

- Pressing ▲ or ▼ in measuring mode selects the measured variable for the left or right display, respectively. The corresponding measurement symbol appears on the right side of the display.
- On the function levels these keys are used to select parameters.
- When entering numerical parameters, they are used to increment or decrement a numeral.
- Pressing ► in the EDIT menu of the Parameter level selects the parameter you want to edit.
- Pressing this key in the VIEW menu or on the Diagnostics level stops automatic line scrolling.

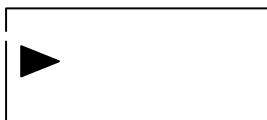

Menu structure

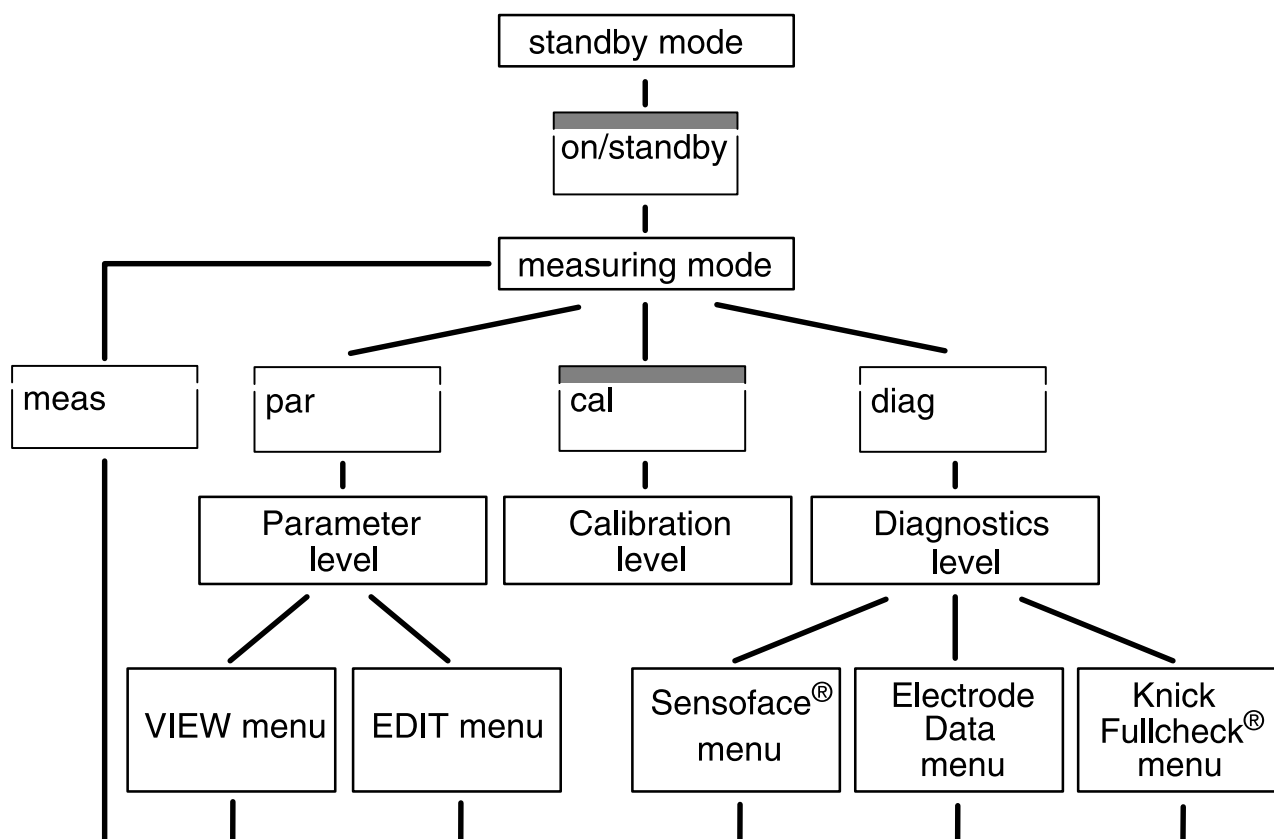

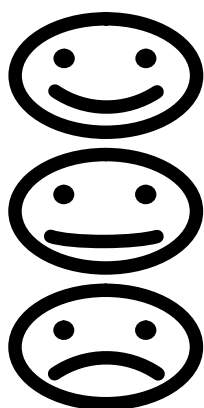

Sensoface[®] automatic electrode monitoring



Sensoface[®] automatic electrode monitoring provides information on the electrode condition. Zero point, slope and response time are evaluated during calibration.

Impedance, dry-out and the calibration timer are evaluated during measurement and in standby mode.

A summary of the individual results is expressed by three face symbols.

-  The electrode is in good condition.
-  The electrode is still usable, but should be calibrated.
-  The electrode urgently requires calibration. If the display does not change after calibration, replace the electrode.

More detailed information on the indicated electrode condition and the individual parameter evaluations is given in chapter "Diagnostics level" (see Pg. 21).



Sensoface[®] was specially designed for monitoring pH electrodes. Since ORP electrodes have completely different characteristics, they provoke invalid Sensoface[®] displays. Therefore, you should disable Sensoface[®] for ORP measurements.

Sensoface[®] display can also be degraded when you use a pH simulator.

Power-on and start-up

Mains supply

The pH meter is designed for 230 VAC supply (Option 363: 115 V AC). Connect the power input of the pH meter to a mains outlet using the included power cord.



If the pH meter is disconnected from mains, clock and calibration timer are not affected (reserve power approx. 1 year). Settings, calibration and diagnostics data remain permanently stored.

Electrode connection

The pH meter can be combined with commercial electrodes: with nominal zero at pH 7 and with

- standard coaxial plug to DIN 19 262 and/or
- 4 mm banana plug.

For special electrodes with differing specifications, we offer Option 346 (nominal zero and slope of electrode user defined).

Connection	Socket
Combination electrode	1
Single sensing electrode	1
Single reference electrode	2
Temp probe of combination electrodes (Electrodes with integrated temp probe)	3
Separate temperature probe	3, 4

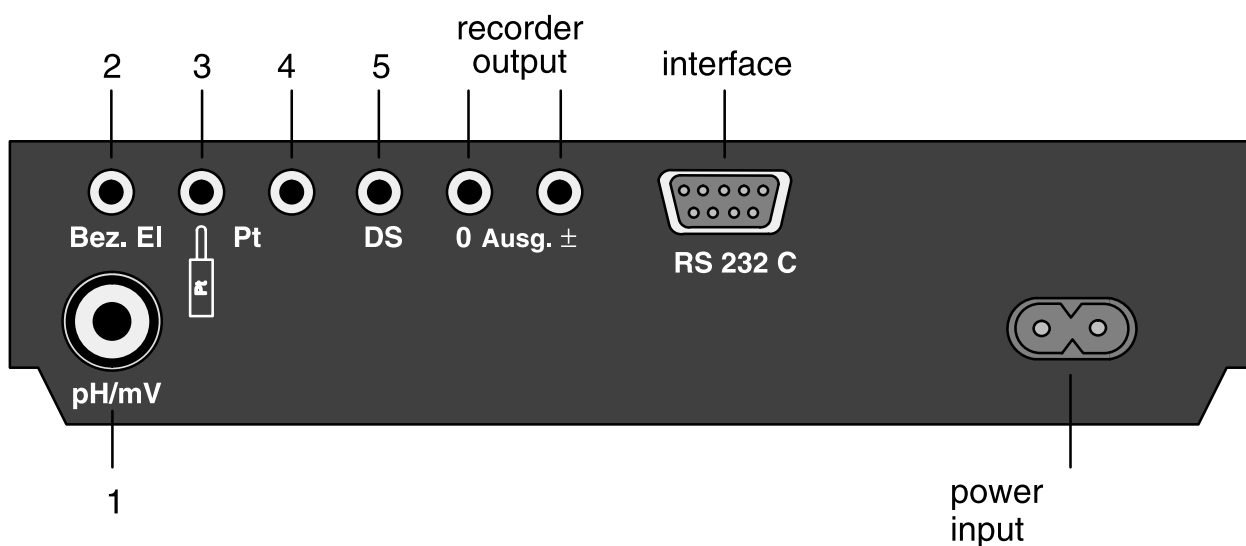

If no temperature probe is connected, the meter uses the manually selected temperature. The decimal point of the temperature display flashes.

If you use double platinum electrodes for voltametrical indication of titrations:

- Connect the banana plugs of the double platinum electrode to sockets 1 and 2.
- To connect the 10 μ A polarization current to the double platinum electrode, connect socket 5 with the inner pole of socket 1 (e.g. using a banana plug with cross hole).



For the RS 232 interface, a shielded cable must be used (e.g. ZU 0152, ZU 0153).

Standby mode

If the meter is connected to a mains outlet but not switched on, it is in standby mode. This is indicated by a lighted Sensoface[®] display.

If Sensoface[®] display is turned off, two measurement symbols are lighting.



Clock and calibration timer are running in standby mode. Knick Drycheck[®] and impedance monitoring are active. Settings, calibration and diagnostics data remain permanently stored. The interface is deactivated.



Pressing **on/standby** switches the meter to measuring mode.

At power-on, the meter performs a short check:

- Simultaneous lighting-up of all display segments, measurement symbols and Sensoface[®] displays
- Display of model name PH 765
- Display of software version
- Display of nominal buffer values of selected buffer set
- Memory test

To stop the short check, press **meas** .



Do not disconnect the meter from mains if you do not use it. Only when the meter remains in standby mode can the electrode be monitored and the battery for the clock be charged.

Measuring mode

In measuring mode both displays indicate the respectively selected measured variable. The variable for the left display is selected using ▲, for the right display using ▼. The corresponding measurement symbol is shown on the right side of the display. You can choose any of the following variables:

- pH value
- Electrode potential [mV]
- Temperature [°C]
- Time

A flashing point on the temperature display indicates that no temperature probe is connected. The meter now uses the manually selected temperature.

print

If you have connected a printer, pressing **print** in the measuring mode gives you a printout of the currently measured values with date and time.

Parameter level



On the Parameter level all variable device parameters are set. Parameters are set in dialog mode using different menus.

Activating parameter setting

Press **par** to exit measuring mode and access the main menu of the Parameter level. To exit Parameter level, press **meas**. It is exited automatically when all parameter setting steps have run through.

Main menu

PAR VIEW

In the main menu of the Parameter level you select the desired submenu using ▲ or ▼. Pressing **enter** confirms your choice and gives access to the corresponding submenu.

The VIEW menu automatically displays all parameters. Settings cannot be changed, however.

- To hold the display, press ►.
- To scroll one line forwards or backwards, press ▲ or ▼, respectively.

PAR EDIT

In the EDIT menu you can view and edit all parameters.

- Select the parameter you want to edit using ▲ or ▼.
- Press ► to start parameter editing. To indicate that the parameter can now be edited, the right display flashes.
- While the right display is flashing, you can edit the parameter using ▲ and ▼. When entering numerical values, select the position using ► and then count up or down using ▲ or ▼.
- Confirm with **enter**. The selected value will be stored and the next parameter displayed.
- You can now select the next parameter using ▼ or **enter** or press ▲ to exit the Parameter level.

Typical setting procedure

6.78^{pH} 23.7^{°C}

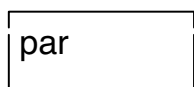

PAR VIEW

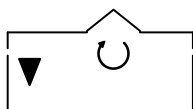

PAR EDIT

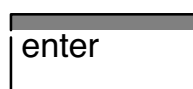

TEMP 20.0

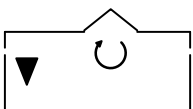

BUFF --01--

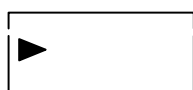

BUFF --01--

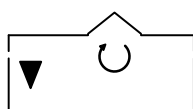

The meter is factory set to calibration buffer set 01 (Mettler Toledo technical trade buffers). However, you want to calibrate using the technical buffer solutions to DIN 19 267, calibration buffer set 03. Therefore, you must select buffer set 03 on the Parameter level.

Press **par** to access the Parameter level.

Press ▼ to select the EDIT menu.

Press **enter** to open the EDIT menu.

Select buffer set parameter BUFF using ▼.

Now press ► to change the buffer set. The right display will flash.

Select buffer set 03, technical buffers to DIN 19 267, using ▼.

BUFF --03--

enter

FCAL NO

meas

Press **enter** to confirm your choice. Buffer set 03 will be stored and the next parameter displayed.

Press **meas** to exit Parameter level.

Printout of parameter record

print

If you have connected the pH meter to a printer, you can print out all stored parameter settings. Press **par** to open the Parameter level. Press **print** to print out all settings. The meter will automatically return to measuring mode.

Parameters

TEMP 20.0

FACE ON

In the following, the individual parameters and their possible settings will be explained.

Manual temperature (–50 to +150 °C)

If no temperature probe is connected, the meter uses the manually selected temperature. In this case, the decimal point of the temperature display will flash in measuring mode.

Sensoface[®] (off / on)

Display of Sensoface[®] electrode monitoring can be turned on or off. If Sensoface[®] display is turned off, standby mode is indicated by two lighted measurement symbols. Display of Sensoface[®] parameters on the Diagnostics level is not affected.

For information on Sensoface[®], refer to chapter "Sensoface[®] menu" (Pg. 22).



Sensoface® was specially designed for monitoring pH electrodes. Since ORP electrodes have completely different characteristics, they provoke invalid Sensoface® displays. Therefore, you should disable Sensoface® for ORP measurements. Sensoface® display can also be degraded when you use a pH simulator.

DSPM OFF

Displaymatic® (off / on)

Displaymatic® can be turned on or off. Displaymatic® ensures a stable measured value display in case of rapid changes of the pH value. This allows for easy reading of the value. It is achieved by suppressing the two running digits behind the decimal point. When the value changes slowly, only the last digit will be suppressed. When the value has stabilized, all digits will be displayed.

Only for meters with Option 346:

Setting the nominal electrode zero point and slope:

NZRO 04.60

Nominal zero (pH 0.00 to 14.00)

For special electrodes with differing nominal zero. The entered zero point is taken as reference for Calimatic®. The exact zero point will be determined during calibration.

NSLP 0030

Nominal slope (25.0 to 61.0 mV/pH)

For special electrodes with differing nominal slope. The entered slope is taken as reference for Calimatic®. The exact slope will be determined during calibration.

UIS -- 125

Isothermal potential (-500 to +500 mV)

The isothermal potential entered here is automatically taken into account for calibration and pH determination.

BUFF --00--

Calibration buffer set (00 to 10)

Select the buffer set with the buffer solutions you are using. The meter has stored eleven different calibration buffer sets.

(see Buffer sets Pg. 49).

BUFF -00- pH	Knick technical buffers	2.00	4.01	7.00	9.21		(25°C)
BUFF -01- pH	Mettler-Toledo technical buffers (correspond to Ingold technical buffers)	2.00	4.01	7.00	9.21		(25°C)
BUFF -02- pH	Merck/Riedel	2.00	4.00	7.00	9.00	12.00	(20 °C)
BUFF -03- pH	DIN19267	1.09	3.06	4.65	6.79	9.23	12.75 (25°C)
BUFF -04- pH	DIN19266 and NIST (NBS)	1.679	4.006	6.865	9.180	12.454	(25°C)
BUFF -05- pH	Merck/Riedel	1.00	3.00	6.00	8.00	10.00	13.00 (20°C)
BUFF -06- pH	Merck	4.66	6.88	9.22			(20°C)
BUFF -07- pH	Ciba(94)	2.06	4.00	7.00	10.00		
BUFF -08- pH	customer specific	2.00	4.62	7.00	8.20	10.00	12.00 (20°C)
BUFF -09- pH	customer specific	2.00	4.01	7.00	9.21	12.00	(25 °C/20 °C)
BUFF -10- pH	Mettler Toledo (USA)	4.00	7.00	10.01			(25 °C)

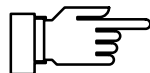

The meter can only operate properly when the buffer solutions used correspond to the selected, activated buffer set.

Other buffer solutions, even those with the same nominal values, may demonstrate a different temperature behavior.

This leads to measurement errors.

FCAL NO

First calibration (no / yes)

With YES, all statistics data will be erased with the next calibration, and the new electrode data will be stored as First Calibration data. After calibration, this parameter will automatically reset to NO.



You should always perform this step when replacing the electrode so that a new statistic is started for the new electrode. For further information on electrode statistics, refer to chapter "Diagnostics level" (Pg. 25).

CTIM 0 168

Calibration timer (0 to 2000 h)

With the calibration timer, you can preset a time interval for the next due calibration. After approx. 80 % of the preset interval have expired, the timer sets the Sensoface[®] display from 😊 to 😊. After the total interval has expired, the display is set to ☹️. The timer is reset by calibration. To turn off the timer, enter 0 as interval time.

OUT PH

Recorder output (pH / mV / °C / PRNT)

The recorder output can output pH value, measured voltage or temperature.

Output voltage:

OUT PH	100 mV/pH
OUT mV	1 mV/mV
OUT ° C	10 mV/°C

With PRNT selected, the recorder output serves as input for activating a print command. With a simple contact, such as a foot switch, the currently measured values can be printed. For further information, refer to chapter "Trueline[®] recorder output" (Pg. 30).



Do not apply an external voltage to the recorder output. The meter might be damaged.

BAUD 9600

Baud rate (600 / 1200 / 2400 / 4800 / 9600)

Here, you can select the interface transmission rate.

DATA 8 NO

Data format (8 NO / 7 EV / 7 OD)

You can choose between:

Data word length	Parity
8 bits	none
7 bits	even
7 bits	odd

PRTC NO

Transmission protocol (NO / XON)

The interface can operate either without transmission protocol or with XON/XOFF protocol.

INTF PRNT

Interface (PRNT / PC)

For direct printer control, select PRNT. You can directly print out measured values and records. To connect the meter to a computer (PC), select PC. The pH meter will be completely computer controllable. All measured values and parameters will be retrievable via computer.

PTIM 0600

Print interval timer (0.1 to 999.9 min)

This step only appears if you have set the interface for printer control. The print interval timer presets an interval for printout of currently measured values with time and date. To turn off the timer, enter 0 as interval time.

TIME 08.15 Time

DATE 19.11 Date

YEAR 1999 Year

END VIEW End of VIEW menu.

END EDIT End of EDIT menu.

Calibration level

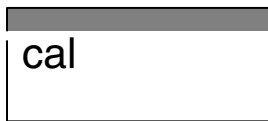

Calibration adjusts the pH meter to the electrode in use. It is adjusted for zero and slope of the electrode.

You only have to select the used buffer set once on the Parameter level. The patented Calimatic® then automatically recognizes the buffer solution in use, calculates zero point and slope of the electrode and adjusts correspondingly. In addition, the Model 765 measures the electrode response time during calibration.

Activating calibration

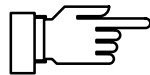

Press **cal** to exit measuring mode and access the Calibration level. You can stop calibration at any time by pressing **meas**.

The meter can only operate properly when the buffer solutions used correspond to the buffer set selected on the Parameter level. Other buffer solutions, even those with the same nominal values, may demonstrate a different temperature behavior. This leads to measurement errors.

CAL 1 YES

Immerse the electrode and temperature probe in the first buffer solution. This can be any of the selected solutions. Press **enter** or **cal** to start calibration. If you do not want to calibrate, select CAL1 NO using ▼ and press **enter** to exit Calibration level.



The response time of the electrode and temperature probe is considerably reduced if the electrode is first moved about in the buffer solution and then held still. The values will stabilize more quickly.

CAL 1 20.0 °C

During buffer recognition CAL 1 is flashing. The right display reads the measured temperature. When you use manual temperature compensation, the entered temperature is displayed. This is indicated by a flashing decimal point.

BUF 1 7.00 pH

The nominal value of the identified buffer solution is displayed for approx. 5 sec. Electrode and temperature probe still remain in the first buffer solution.

0 mV 0 II time

Stability of the electrode is checked. The left-hand display reads the measured mV value. The right-hand display shows a running clock measuring the electrode response time. For each revolution (4 sec), a mark is added to the tally beside the clock. Stability check can be stopped by pressing **cal**. However, this reduces calibration accuracy.

CAL2 YES

Calibration with the first buffer is terminated. Take the electrode and temperature probe out of the solution and rinse them thoroughly.

- If you only want to perform a one-point calibration, press **meas** to stop calibration, or select CAL2 NO using ▼ and press **enter** to exit the Calibration level. The meter will display the new, calculated zero point and the old slope and return to measuring mode.
- If you want to perform a two-point calibration, immerse the electrode and temperature probe in the second buffer solution. Press **enter** or **cal** to restart calibration. The calibration process runs again as for the first buffer.

CAL2 20.0 °C

Buffer recognition, CAL 2 flashing, display of temperature

BUF2 9.21^{pH}

Display of nominal buffer value for approx. 5 sec

-- 128^{mV} 0" time

Check of electrode stability and response time

ZERO 7.01^{pH}

Display of zero point determined for the electrode

SLOP 57.6

Display of slope determined for the electrode

END CAL

End of calibration

Printing calibration record

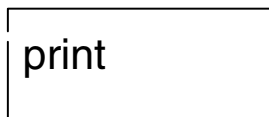

If you have connected the meter to a printer, you can print out a record of the last calibration.

Press **cal** to open the Calibration level.

Press **print** to print out the complete record of the last calibration. The meter will automatically return to measuring mode.

Diagnostics level



On the Diagnostics level the complete pH measurement equipment is checked. This also serves for quality management to ISO 9000.

Activating diagnostics

Press **diag** to exit measuring mode and access the main menu of the Diagnostics level. To exit Diagnostics level, press **meas**. It is exited automatically when all diagnostics functions have been performed.

Main menu

In the main menu you select the desired function of the Diagnostics level using ▲ or ▼. Pressing **enter** gives access to the corresponding sub-menu.

DIAG FACE

The Sensoface[®] menu shows the states of the criteria that control Sensoface[®] display.

DIAG EDAT

The Electrode Data menu shows the electrode data calculated during last calibration, the calibration timer count and the electrode statistics.

DIAG TEST

The Knick Fullcheck[®] menu provides a complete device self test to check the operability of the individual device components.

All submenus are run automatically but can be influenced via keypad.

- To stop the sequence, press ►. To restart it, press ► once more.
- To scroll one step forwards or backwards, press ▲ or ▼, respectively.

Sensoface[®] menu

DIAG FACE

In the Sensoface[®] menu you see the criteria that control Sensoface[®] display. Each criterion is displayed separately with the corresponding evaluation. This gives you important information on the condition of your electrode. Sensoface[®] alerts you in time for possible errors or aging of your electrode.

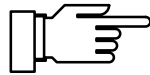

The worsening of a Sensoface[®] criterion leads to the devaluation of the Sensoface[®] display. This devaluation is permanent. An improvement can only take place after a calibration.

ZERO SLOP

Here, the Sensoface[®] display provides information on zero and slope of the electrode. For the exact zero and slope values, refer to the Electrode Data menu.



Zero and slope of the electrode are okay.



Zero and slope of the electrode are still okay. However, the electrode should be replaced soon.



Zero and/or slope of the electrode have reached values which no longer ensure proper calibration. It is advisable to replace the electrode.

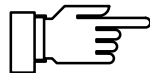

The values for zero and slope are determined during calibration only. Therefore, correct information depends on a proper calibration. Make sure that you always use correct and pure buffer solutions.

EL - TIME

The Sensoface® display provides information on the electrode's response time. This is the time the electrode requires for delivering a stable measured value. The value determined during calibration. Wear and aging, but also wrong treatment (such as dry storage) can reduce the gel layer of the glass membrane. This results in a longer response time. The electrode gets sluggish.



The electrode promptly adjusts to the measured value.



The electrode adjusts slowly. You should consider replacing it. It may be possible to achieve an improvement by cleaning, or in the case of an electrode stored dry, by "watering".



The electrode adjusts very slowly to the measured value. Correct measurement is no longer ensured. The electrode should be replaced.

CAL -- TIME

On the Parameter level, the calibration timer allows to preset a time interval for the next due calibration. The calibration timer keeps running in standby mode and with mains supply disconnected.



The calibration interval is still running.



Over 80 % of the calibration interval have run out.



The calibration interval has been exceeded.

END FACE

End of Sensoface[®] menu.

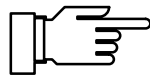

Sensoface[®] was specially designed for monitoring pH electrodes. Since ORP electrodes have completely different characteristics, they provoke invalid Sensoface[®] displays. Therefore, you should disable Sensoface[®] for ORP measurements. Sensoface[®] display can also be degraded when you use a pH simulator.

Electrode Data menu

DIAG E DAT

The Electrode Data menu shows the values for zero and slope of the electrode calculated during the last calibration, the cal timer count, and the electrode statistics.

ZERO 7.00

Display of electrode zero determined during last calibration.

SLOP 59.1

Display of electrode slope determined during last calibration.

NCAL 0074

Display of time in hours until the next calibration is requested by the timer.

EL-- STAT

The electrode statistics include the electrode zero, slope and response time of the last three calibrations with corresponding date and time. In addition, the data of the first calibration (see Pg. 15) performed on this electrode are provided. This allows you to evaluate electrode behavior over its whole life span. Since the data are very comprehensive, they should be printed out or read out via computer.

''' DAT 15. 10

Date of last calibration

'' DAT 14. 10

Date of second last calibration

' DAT 13. 10

Date of third last calibration

* DAT 06. 10

Date of first calibration

"TIM	8.06	Time of last calibration
"TIM	8.10	Time of second last calibration
'TIM	8.07	Time of third last calibration
*TIM	14.36	Time of first calibration
"ZRO	7.01	Electrode zero determined during last calibration
"ZRO	7.01	Electrode zero determined during second last calibration
'ZRO	7.00	Electrode zero determined during third last calibration
*ZRO	7.00	Electrode zero determined during first calibration
"SLP	59.1	Slope determined during last calibration
"SLP	59.1	Slope determined during second last calibration
'SLP	59.1	Slope determined during third last calibration
*SLP	59.2	Slope determined during first calibration

'''SEC 00 18

Electrode response time of last calibration

''SEC 00 19

Electrode response time of second last calibration

'SEC 00 18

Electrode response time of third last calibration

*SEC 00 17

Electrode response time of first calibration

END EDAT

End of Electrode Data menu.

Knick Fullcheck® menu

DIAG TEST

With the Knick Fullcheck® menu, a complete device self-test is performed. The complete measuring circuitry, measured value processing, memories, display and keypad are checked and each result is displayed. The tests run automatically. Only during keypad testing you have to press the requested keys. Longer testing periods are indicated by a little running clock on the right display.

--OK--

Successful testing is confirmed by OK on the right display.

RAM -----

RAM test

PROM -----

EPROM test

EEPR -----

EEPROM test

AMPL TEST

Amplifier linearity test: Using an integrated, high-precision reference, the complete measuring circuitry from input amplifier to recorder output is checked. The displayed mV values lie across the recorder output. The electrode is internally disconnected from the amplifier.

-1500 mV 

Linearity test at -1500 mV

-- 750 mV 

Linearity test at -750 mV

0 mV 

Linearity test at 0 mV

750 mV 

Linearity test at +750 mV

1500 mV 

Linearity test at +1500 mV

IMP 

































Test of impedance measuring circuit

WAIT 

Amplifier linearity test is terminated. The device takes a few seconds to bumplessly reconnect the electrode to the amplifier.

DISPL TEST

Display test: All Sensoface[®] indicators, all segments of the two LED displays and all measurement symbols light up.

          pH
mV
°C
time                       pH
mV
°C
time

Check whether really everything is lighting.

KEY TEST

During keypad testing, you are prompted to press the corresponding key.

PUSH MEAS

Press **meas** .

PUSH PRNT

Press **print** .

PUSH UP

Press ▲ .

PUSH CURS

Press ► .

PUSH DOWN

Press ▼ .

PUSH ON

Press **on/standby** .

PUSH CAL
PUSH PAR
PUSH DIAG
PUSH ENTR
END TEST

Press **cal** .

Press **par** .

Press **diag** .

Press **enter** .

End of device test

Printing diagnostics record

print

If you have connected the meter to a printer, you can print out a record of the diagnostics.

Press **diag** to open the Diagnostics level.

Press **print** to print out the complete diagnostics record.

Trueline[®] recorder output

The Trueline[®] recorder output was developed for the 765 Laboratory pH Meter. Trueline[®] supplies an analog output signal without disturbing voltage steps, but being calibrated to pH. Galvanic output isolation is standard. Connected recorders and data acquisition systems thus do not have to be floating.

On the Parameter level, the output can be set for three different input variables:

Input variable	Output voltage
pH value	100 mV/pH
Voltage	1 mV/mV
Temperature	10 mV/°C

If pH has been selected as output variable, the output voltage zero is at pH 7. For meters with Option 346 (Nominal electrode zero and slope user-defined), the output voltage zero is at the selected nominal zero point.

If the recorder output has been set for printer control, a voltage of approx. 1.5 V lies across its output. By short-circuiting (current approx. 1.5 mA), e.g. using a foot switch, you can print out the currently measured values.

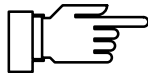

Do not apply an external voltage to the recorder output. The meter might be damaged.

Serial interface

The Model 765 comes with an RS 232 interface. The interface is user-definable for direct control of a printer with serial input or for direct connection to a computer. The pH meter is completely computer controllable and all values and parameters can be read out.

Interface parameters

The RS 232 interface is user-definable for all common baud rates and data protocols.

Settings are made on the Parameter level.

- Baud rate: 600 / 1200 / 2400 / 4800 / 9600 Bd

- Data format:

Data word length	Parity	Stop bit
7 bits	even	1
7 bits	odd	1
8 bits	none	1

- Protocol: No protocol
XON/XOFF bidirectional handshake
If not ready to accept data,
the meter transmits XOFF < 13 > H,
if ready to accept data, XON < 11 > H

Pin assignment

The pH meter has a 9-pin D SUB connector (connector with pin contacts). The metallic connector shell is connected to signal ground via a capacitor and provides EMI shielding.

Contact	Signal	Input/Output
2	(RD) Received data	Input
3	(TX) Transmitted data	Output
5	(SGND) Signal ground	
4,6,8	Jumpered	

Interface cable

Knick offers as accessory:

- ZU 0245 interface cable for connecting the pH meter to the ZU 0244 Lab Printer.
- ZU 0152 interface cable for connecting the pH meter to a computer (PC):

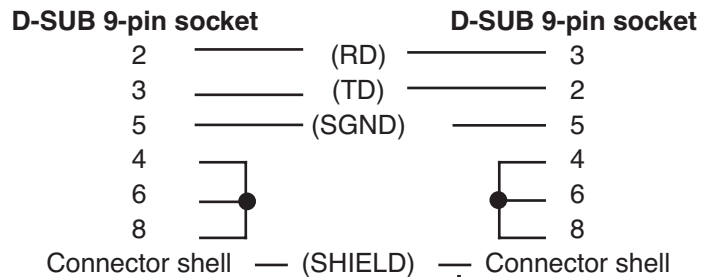

Standard settings for ZU 0244 Lab Printer

Settings on Laboratory pH Meter

Parameter	Value to be set	Setting
Baud rate	4800 Bd	4800
Data format	7 data bits, parity even	7 EV
Protocol	XON/XOFF	XON
Interface	Printer	PRNT

Command set for the serial interface

The pH meter's command set is divided into read and write commands.

- Read commands start with "R". They read out data from the pH meter. Read commands always return a response. Device function is not affected.
- Write commands start with "W". They send commands and parameters to the pH meter. A write command modifies device settings or parameters. The meter does not return a response. Acknowledgement of write commands can be enabled with the "WPMSR1" command. Then the meter will return "CR" (carriage return <0D> H) after each write command.

Message terminator

Message terminators for read and write

- Read: The pH meter terminates the string by "CR" (carriage return <0D> H).
- Write: The pH meter expects "CR" or "LF" (line feed <0A> H) or any combination of these as message terminator.

Numerical parameters

Format of a numerical parameter

- Mantissa:
 - preceded by +, -, blank or without sign
 - up to 14 valid digits incl. sign
 - Decimal point or comma floating or without
- Exponent:
 - "E" indicates exponent beginning
 - + or - sign
 - 1 to 3 digits
 - Exponent may be omitted.

Example: +1234567E-123

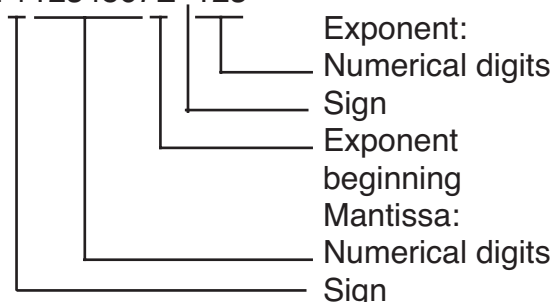

Reading measured values or results

Com-mand	Response	Unit	Description
RV0	± xx.xx	[pH]	pH value
RV1	± xxxxE-3	[V]	Electrode potential
RV2	± xxx.x	[°C]	Pt100/Pt1000 temperature
RVTRT	xxxx	[hhmm]	Time: hours/minutes
RVDRT	xxxxxx	[ddmmyy]	Date: day/month/year
RVTCA	xxxx	[h]	Calibration timer count
RVZA	± xx.xx	[pH]	Current electrode zero point
RVSA	± xxxxE-3	[V/pH]	Current electrode slope

Reading error messages

Com-mand	Response	Description
RSF1	xx	First error message
RSFA	xx;xx;xx;...	All active error messages

List of error messages (xx):

List of error messages (xx):

01	pH range -2.00 to +16.00 exceeded
02	mV range -2000 to +2000 mV exceeded
03	°C range -50. to +150 °C exceeded
04	Zero range pH 6.00 to 8.00 exceeded
05	Slope range 47.0 to 67.0 mV/pH exceeded
09	Buffer cannot be identified
10	Identical buffers
20	Interface error
90	System failure

Reading operating states

Com-mand	Re-sponse	Description
RSP	xx	Operating states
	00	Measuring mode
	01	Parameter mode
	02	Calibration mode
	08	Diagnostics mode

Reading Sensoface[®] states

Com-mand	Re-sponse	Description
RSES	x	Sensoface [®] display
RSEZS	x	Sensoface [®] : zero/slope
RSETR	x	Sensoface [®] : electrode response
RSERG	x	Sensoface [®] : electrode impedance
RSERT	x	Sensoface [®] : Drycheck
RSETC	x	Sensoface [®] : Calibration timer

List of Sensoface[®] messages (x):

0	
1	
2	

Query keypad

Com- mand	Re- sponse	Description
RSK	xx	Query keypad
	00	cal key
	01	print key
	02	▲ key
	03	meas key
	04	on/standby key
	05	enter key
	06	par key
	07	diag key
	08	▼ key
	09	▶ key

Reading results of Knick Fullcheck[®] self test

Command	Re- sponse	Unit	Description
RSTET	xxxx	[hhmm]	Last Fullcheck/ time
RSTED	xxxxxx	[ddmmyy]	Last Fullcheck/date
RSTERR	x		RAM test
RSTERP	x		EPROM test
RSTERE	x		EEPROM test
RSTERA	x		Amplifier test
RSTERI	x		Impedance test
RSTERDI	x		Display test
RSTERKY	x		Keypad test

List of test results

0	ok (display test executed)
1	Test not executed
2	Defective

Reading calibration data

Command	Response	Unit	Description
RSCPT	xxxx	[hhmm]	Last calibration/ time
RSCPD	xxxxxx	[ddmmyy]	Last calibration/ date
RSCPS	xx		Buffer set
RSCP1NB	± xx.xx	[pH]	Buffer 1: nominal value
RSCP11	± xxxxE-3	[V]	Buffer 1: electrode potential
RSCP12	± xxx.x	[°C]	Buffer 1: temperature
RSCP1TR	xxxx	[s]	Buffer 1: response time

Command	Response	Unit	Description
RSCP2NB	± xx.xx	[pH]	Buffer 2: nominal value
RSCP21	± xxxxE-3	[V]	Buffer 2: electrode potential
RSCP22	± xxx.x	[°C]	Buffer 2: temperature
RSCP2TR	xxxx	[s]	Buffer 2: response time

Reading electrode statistics

Com- mand	Response	Unit	Description
Record 3 (last calibration):			
RSSTT3	xxxx	[hhmm]	Calibration/time
RSSTD3	xxxxxx	[ddmmyy]	Calibration/date
RSSTZ3	± xx.xx	[pH]	Electrode zero point
RSSTS3	± xxxxE-3	[V/pH]	Electrode slope
RSSTTR3	xxxx	[s]	Electrode response
Record 2 (second last calibration):			
RSSTT2	xxxx	[hhmm]	Calibration/time
RSSTD2	xxxxxx	[ddmmyy]	Calibration/date
RSSTZ2	± xx.xx	[pH]	Electrode zero point
RSSTS2	± xxxxE-3	[V/pH]	Electrode slope
RSSTTR2	xxxx	[s]	Electrode response
Record 1 (third last calibration):			
RSSTT1	xxxx	[hhmm]	Calibration/time
RSSTD1	xxxxxx	[ddmmyy]	Calibration/date
RSSTZ1	± xx.xx	[pH]	Electrode zero point
RSSTS1	± xxxxE-3	[V/pH]	Electrode slope
RSSTTR1	xxxx	[s]	Electrode response
Record 0 (first calibration):			
RSSTT0	xxxx	[hhmm]	Calibration/time
RSSTD0	xxxxxx	[ddmmyy]	Calibration/date
RSSTZ0	± xx.xx	[pH]	Electrode zero point
RSSTS0	± xxxxE-3	[V/pH]	Electrode slope
RSSTTR0	xxxx	[s]	Electrode response

Reading parameters

Command	Response	Unit	Description
RPTMMV	± xxx.x	[°C]	Manual temperature
RPCATI	xxxx	[h]	Calibration timer interval
RPINPTI	xxx.x	[min]	Print timer interval
RPMSR	x		Response to write command on/off
	0		Off
	1		On
RPDIE	x		Sensoface® on/off
	0		Off
	1		On
RPDIDA	x		Displaymatic® on/off
	0		Off
	1		On
RPAINA	x		Assignment for recorder output
	0		pH
	1		mV
	2		Temperature
	8		Input for printer control
RPCASA	xx		Calibration buffer set
	00		Knick technical buffers
	01		Mettler Toledo technical buffers
	02		Merck Titrisol buffers
	03		Techn. buffers to DIN 19 276
	04		Standard buffers to DIN 19 266
	05		Merck Titrisol buffers
	06		Merck buffers ready to use
	07		Ciba (94)
	08		customer specific
	09		customer specific
	10		Mettler Toledo (USA)

**Only for meters
with Option 346:**Only for meters with Option 346: Nominal electrode
zero and slope user-defined

Com- mand	Response	Unit	Description
RPCA0NZ	$\pm xx.xx$	[pH]	Nominal zero
RPCA0NS	$\pm xxxxE-3$	[V/pH]	Nominal slope
RPCA0U	$\pm xxxxE-3$	[V]	V iso isothermal potential

Writing parameters

Command	Parameter	Unit	Description
WPTMMV	Num. par.	[°C]	Manual temperature
WPCATI	Num. par.	[h]	Calibration timer interval
WPINPTI	Num. par.	[min]	Print timer interval
WPMSR	x		Response to write command on/off
	0		Off
	1		On
WPDIE	x		Sensoface® on/off
	0		Off
	1		On
WPDIDA	x		Displaymatic® on/off
	0		Off
	1		On
WPAINA	x		Assignment of recorder output
	0		pH
	1		mV
	2		Temperature
	8		Input for printer control
WPCASA	xx		Calibration buffer set
	00		Knick techn. buffers
	01		Mettler Toledo technical buffers
	02		Merck Titrisol buffers
	03		Techn. buffers to DIN 19 276
	04		Standard buffers to DIN 19 266
	05		Merck Titrisol buffers
	06		Merck buffers ready to use
	07		Ciba (94)
	08		customer specific
	09		customer specific
	10		Mettler Toledo (USA)

Only for meters with Option 346:

Nominal electrode zero and slope are set as follows:

Command	Parameter	Unit	Description
WPCA0NZ	Num. par.	[pH]	Nominal zero point
WPCA0NS	Num. par.	[V/pH]	Nominal slope
WPCA0U	Num. par.	[V]	V iso isothermal potential

Control commands

Command	Description
WCIU	Initialize device
WCTEA	Perform Fullcheck
WCRTT [hhmm]	Set time
WCRTD [ddmmyy]	Set date
WCOM00	Switch to measuring mode
WCCASTI	Set first calibration (only for Option 347)
WCCAA1	Start calibration with 1st buffer
WCCAA2	Start calibration with 2nd buffer
WCDISLA0	Left display, indicate pH
WCDISLA1	Left display, indicate mV
WCDISLA2	Left display, indicate temperature
WCDISLATRT	Left display, indicate time
WCDISRA0	Right display, indicate pH
WCDISRA1	Right display, indicate mV
WCDISRA2	Right display, indicate temperature
WCDISRATRT	Right display, indicate time

Reading device description

Command	Response	Description
RDMF	KNICK	Manufacturer
RDUN	765	Model name
RDUS	xxxxxx	Serial number
RDUV	xx;xx	Software/hardware version
RDUP	xxx;xxx;xxx	Options

3 Troubleshooting

Error messages

Range exceeded

ERR --PH--

If a measured value is out of range, an error message is displayed instead of the value measured.

The measured pH value is
< -2 or > +16.

Possible causes:

- Electrode defective
- Too little electrolyte in electrode
- Electrode not connected
- Break in electrode cable
- Incorrect electrode connected, e.g. ORP electrode

ERR --mV--

The measured electrode potential is
< -1999 mV or > +1999 mV.

Possible causes:

- Electrode defective
- Electrode not connected
- Break in electrode cable

ERR TEMP

The measured temperature is
< -50 °C or > +150 °C

Possible causes:

- Temperature probe defective

Calibration error messages

When errors occur during calibration or when the determined electrode data are out of range, an error message will be displayed.

FAIL BUFF

The meter cannot identify the buffer solution in use. This message is only momentarily displayed during calibration.

Possible causes:

- Buffer solution does not belong to the selected buffer set
- Electrode defective
- Electrode not connected
- Break in electrode cable
- Wrong buffer temperature selected (for manual temperature compensation)

SAME BUFF

The meter identified two identical buffer solutions. This message is only momentarily displayed during calibration.

Possible causes:

- Same or similar buffer solution used for second calibration step
- Buffer solutions contaminated
- Electrode defective
- Electrode not connected
- Break in electrode cable

EL INST

Calibration was canceled after approx. 2 minutes, because the electrode drift was too large. This message is only momentarily displayed during calibration.

Possible causes:

- Electrode defective
- No electrolyte in the electrode
- Electrode cable not sufficiently shielded or defective
- Strong electric fields influence the measurement
- Major temperature fluctuation of the buffer solution
- No buffer solution or extremely diluted

ERR ZERO

The electrode zero determined during calibration is out of range. Electrode zero is < pH 6 or > pH 8
(for Option 346: at ± 1 pH unit from nominal zero)

This message is displayed in measuring mode after a calibration. It can only be reset by a new calibration.

Possible causes:

- Electrode "worn out"
- Buffer solutions contaminated
- Temperature probe not immersed in buffer solution (for automatic temperature compensation)
- Wrong buffer temperature selected (for manual temperature compensation)
- Used electrode has different nominal zero point

ERR SLOP

The electrode slope determined during calibration is out of range.

The electrode slope is < 47.0 mV/pH or > 61.0 mV/pH (for Option 346: at ± 7 mV/pH from nominal slope). This message is displayed in measuring mode after a calibration. It can only be reset by a new calibration.

Possible causes:

- Electrode "worn out"
- Buffer solutions contaminated
- Temperature probe not immersed in buffer solution (for automatic temperature compensation)
- Wrong buffer temperature selected (for manual temperature compensation)
- Used electrode has different nominal slope

Interface error message

ERR INTF

When errors occur during transmission via interface, an error message is displayed.

The meter has received an invalid interface command.

Possible causes:

- Syntax error in interface command
- Too many characters in one string
- No valid message terminator
- Wrong transmission rate (baud rate) selected
- Wrong data word length or parity selected
- Wrong transmission protocol (handshake) selected
- Interference during transmission

System error message

ERR SYST

When a system error is found during the self test, an error message is displayed.

Error in the configuration or calibration data or in the factory settings

Possible causes:

- Clock defective
- EPROM, EEPROM or RAM defective
- Error in factory settings



This error message normally should not occur, as the data are protected from loss by multiple safety functions. Should this error message nevertheless occur, there is no remedy. The meter must be recalibrated at the factory.



Opening the meter exposes live parts. Therefore, it shall not be opened. If a repair should be required, return the meter to our factory.

Appendix

Product line

		Ref. No.
Device	pH meter with power cord, without electrode	765
Accessories	Attachable stand, for ZU 6955 immersion stirrer and three sensors, directly connected to pH meter	ZU 6954
	Immersion stirrer, powered via ZU 6956 power pack	ZU 6955
	Power pack for immersion stirrer	ZU 6956
	Lab Printer	ZU 0244
	Interface cable for connecting the Model 765 to a printer (ZU 0244)	ZU 0245
	Interface cable for connecting the Model 765 to a computer (special EMC cable)	ZU 0152
Sensors and buffer solutions	Combination pH/Pt 1000 electrode (glass, with integrated Pt 1000 temp probe 0 to 80 °C, pH 0 to 14)	SE 100
	Combination pH electrode (glass, without temperature probe, 0 to 100 °C, pH 0 to 14)	SE 103
	Pt 1000 temperature probe, for fast response temperature measurements (stainless steel, -10 to +100 °C)	ZU 6959
	Calibration buffer set with Knick technical buffer solutions (250 ml each of pH 4, pH 7, pH 9 and KCl solution)	ZU 0261
	Calibration buffer set with standard buffer solutions to DIN 19 266 and NIST (NBS) (250 ml each of pH 4, pH 7 and KCl solution)	ZU 6941
Options	Power supply 115 V AC	363
	Nominal electrode zero point and slope user-defined	346

Specifications

Ranges	pH: -2.00 to +16.00 mV: -1999 to +1999 °C: -50.0 to +150.0
Display	Alphanumeric, 2 x 4 digits, 14-segment LED, Character height 13 mm Parameters: pH/mV/°C/time 3 status indicators for electrode condition
Measuring cycle	Approx. 1/sec
Accuracy*	pH: < 0.01 mV: < 0.1 % ± 0.3 mV °C: < 0.3 K
Input	DIN 19 262
Input resistance	> 1 * 10 ¹² Ohms
Input current	< 1 * 10 ⁻¹² A (20°C)**
Temperature coefficient	< 0.1 count/K
Electrode standardization	Calimatic® automatic calibration and buffer recognition (German patent 29 37 227) For buffer tables, see Appendix Calibration ranges: Zero: pH 6 to 8 Slope: 47 to 61 mV/pH (25°C)
(Option 346)	Nominal zero / slope / V iso*** Zero: pH 0 to 14 Slope: 25 to 61 mV/pH V iso: -500 to +500 mV

* ± 1 count

** 45°C: factor 10

*** User-defined

Electrode monitoring	<p>Sensoface® : Evaluation of zero point, slope, response time and impedance of electrode, and of calibration interval. Electrode condition displayed as good/average/poor, can be disabled</p> <p>Knick Drycheck® : Monitors electrode impedance for dry-out, glass breakage and defective connections, also in standby mode Calibration timer monitors a preset calibration interval</p>
Knick Fullcheck® device self-test	Test of complete measurement electronics including recorder output, segment and keypad test in Diagnostics mode, automatic short check at power-on
Records	<p>Parameter record Calibration record Diagnostics record Records for QM documentation to ISO 9000 and GLP* , retrievable via interface (printer) or display</p>
Displaymatic®	Digit suppression according to signal change, can be disabled
Temperature compensation	Pt 100 / Pt 1000, automatic selection
Dead stop current	Manual: -50.0 to +150 °C -10 µA
Trueline® recorder output	Galvanically isolated, pH compensated
	<p>mV: 1 mV/mV pH: 100 mV/pH °C: 10 mV/°C Isolation voltage: 40 V DC, 20 V AC</p>

* Good Laboratory Practice

Remote interface	RS 232 without control lines, galvanically isolated, user defined as printer or computer interface Baud rate: 600/1200/2400/4800/9600 * Data formats: 7 bits even/odd * 8 bits without parity * Protocol: None, XON/XOFF * Stop bits: 1 Isolation voltage: 40 V DC, 20 V AC
Printer control	for standard printer with serial port, printing at keystroke or via print interval timer 0.1 to 999.9 min
Clock	Clock with date, self-contained
Calibration data storage	Automatic storage of calibration data, self-contained
Data retention	Parameters, statistics and factory settings: >10 years (EEPROM) Clock: Reserve power >1 year (battery-backed)
Electrode statistics	Storage of zero and slope of first calibration, as well as data of last three calibrations with time and date, self-contained, output via interface to printer or computer.
EMC	2004/108/EC Emitted interference: Class B Immunity to interference: Industry Standards: DIN EN 61326 -1 (VDE 0843 Part 20-1): 2006-10 DIN EN 61326-2-3 (VDE 0843 Part 20-2-3): 2007-05
Low-voltage directive	2006/95/EC Standards: EN 61010-1: 2001
Operating temp	0 to +45 °C
Storage and transport temp	-20 to +70 °C

* User-defined

Power supply	230 V –15 % +10 %, 48 to 62 Hz, < 10 VA, Class II  Option 363: 115 V AC
Enclosure	Glass reinforced polyamide 12, stainless steel cover, IP 54 protection, ready for connection of ZU 6954 attachment stand
Dimensions	244 x 95 x 255 mm (w x h x d)
Weight	Approx. 2 kg

Buffer tables

Buffer set 00

Knick technical buffers

°C	pH			
0	2.03	4.01	7.12	9.52
5	2.02	4.01	7.09	9.45
10	2.01	4.00	7.06	9.38
15	2.00	4.00	7.04	9.32
20	2.00	4.00	7.02	9.26
25	2.00	4.01	7.00	9.21
30	1.99	4.01	6.99	9.16
35	1.99	4.02	6.98	9.11
40	1.98	4.03	6.97	9.06
45	1.98	4.04	6.97	9.03
50	1.98	4.06	6.97	8.99
55	1.98	4.08	6.98	8.96
60	1.98	4.10	6.98	8.93
65	1.99	4.13	6.99	8.90
70	1.99	4.16	7.00	8.88
75	2.00	4.19	7.02	8.85
80	2.00	4.22	7.04	8.83
85	2.00	4.26	7.06	8.81
90	2.00	4.30	7.09	8.79
95	2.00	4.35	7.12	8.77

Buffer set 01

Mettler-Toledo technical buffers
(correspond to Ingold technical buffers)

°C	pH				
0	2.03	4.01	7.12	9.52	
5	2.02	4.01	7.09	9.45	
10	2.01	4.00	7.06	9.38	
15	2.00	4.00	7.04	9.32	
20	2.00	4.00	7.02	9.26	
25	2.00	4.01	7.00	9.21	
30	1.99	4.01	6.99	9.16	
35	1.99	4.02	6.98	9.11	
40	1.98	4.03	6.97	9.06	
45	1.98	4.04	6.97	9.03	
50	1.98	4.06	6.97	8.99	
55	1.98	4.08	6.98	8.96	
60	1.98	4.10	6.98	8.93	
65	1.99	4.13	6.99	8.90	
70	1.99	4.16	7.00	8.88	
75	2.00	4.19	7.02	8.85	
80	2.00	4.22	7.04	8.83	
85	2.00	4.26	7.06	8.81	
90	2.00	4.30	7.09	8.79	
95	2.00	4.35	7.12	8.77	

Buffer set 02

Merck Titrisol buffers and ready-to-use buffer
solutions, Riedel Fixanal buffers and ready-to-use
buffer solutions

°C	pH				
0	2.01	4.05	7.13	9.24	12.58
5	2.01	4.04	7.07	9.16	12.41
10	2.01	4.02	7.05	9.11	12.26
15	2.00	4.01	7.02	9.05	12.10
20	2.00	4.00	7.00	9.00	12.00
25	2.00	4.01	6.98	8.95	11.88
30	2.00	4.01	6.98	8.91	11.72
35	2.00	4.01	6.96	8.88	11.67
40	2.00	4.01	6.95	8.85	11.54
45	2.00	4.01	6.95	8.82	11.44
50	2.00	4.00	6.95	8.79	11.33
55	2.00	4.00	6.95	8.76	11.19
60	2.00	4.00	6.96	8.73	11.04
65	2.00	4.00	6.96	8.72	10.97
70	2.01	4.00	6.96	8.70	10.90
75	2.01	4.00	6.96	8.68	10.80
80	2.01	4.00	6.97	8.66	10.70
85	2.01	4.00	6.98	8.65	10.59
90	2.01	4.00	7.00	8.64	10.48
95	2.01	4.00	7.02	8.64	10.37

Buffer set 03

Technical buffer solutions to DIN 19 267

°C	pH					
0	1.08	3.14*	4.67	6.89	9.48	13.95*
5	1.08	3.12*	4.67	6.87	9.43	13.63*
10	1.09	3.10	4.66	6.84	9.37	13.37
15	1.09	3.08	4.66	6.82	9.32	13.16
20	1.09	3.07	4.65	6.80	9.27	12.96
25	1.09	3.06	4.65	6.79	9.23	12.75
30	1.10	3.05	4.65	6.78	9.18	12.61
35	1.10	3.05	4.65	6.77	9.13	12.45
40	1.10	3.04	4.66	6.76	9.09	12.29
45	1.10	3.04	4.67	6.76	9.04	12.09
50	1.11	3.04	4.68	6.76	9.00	11.98
55	1.11	3.04	4.69	6.76	8.96	11.79
60	1.11	3.04	4.70	6.76	8.92	11.69
65	1.11	3.04	4.71	6.76	8.90	11.56
70	1.11	3.04	4.72	6.76	8.88	11.43
75	1.11	3.04	4.73	6.77	8.86	11.31
80	1.12	3.05	4.75	6.78	8.85	11.19
85	1.12	3.06	4.77	6.79	8.83	11.09
90	1.13	3.07	4.79	6.80	8.82	10.99
95	1.13*	3.08*	4.82*	6.81*	8.81*	10.89*

* Extrapolated

Buffer set 04

Standard buffer solutions to DIN 19 266 and NIST (NBS)

°C	pH				
0	1.666	4.010	6.948	9.464	13.423
5	1.668	4.004	6.951	9.395	13.207
10	1.670	4.000	6.923	9.332	13.003
15	1.672	3.999	6.900	9.276	12.810
20	1.675	4.001	6.881	9.225	12.627
25	1.679	4.006	6.865	9.180	12.454
30	1.683	4.012	6.853	9.139	12.289
35	1.688	4.021	6.844	9.102	12.133
40	1.694	4.031	6.838	9.068	11.984
45	1.700	4.043	6.834	9.038	11.841
50	1.707	4.057	6.833	9.011	11.705
55	1.715	4.071	6.834	8.985	11.574
60	1.723	4.087	6.836	8.962	11.449
65	1.733	4.109	6.841	8.942	11.330*
70	1.743	4.126	6.845	8.921	11.210*
75	1.755	4.145	6.852	8.903	11.100*
80	1.766	4.164	6.859	8.885	10.990*
85	1.779	4.185	6.868	8.868	10.890*
90	1.792	4.205	6.877	8.850	10.790*
95	1.806	4.227	6.886	8.833	10.690*

* Extrapolated

Buffer set 05

Merck Titrisol buffers and ready-to-use buffer solutions, Riedel Fixanal buffers and ready-to-use buffer solutions

°C	pH					
0	0.96	3.05	6.04	8.15	10.26	13.80
5	0.99	3.05	6.02	8.10	10.17	13.59
10	0.99	3.03	6.01	8.07	10.11	13.37
15	0.99	3.01	6.00	8.04	10.05	13.18
20	1.00	3.00	6.00	8.00	10.00	13.00
25	1.01	3.00	6.02	7.96	9.94	12.83
30	1.01	3.00	6.03	7.94	9.89	12.67
35	1.01	3.00	6.03	7.92	9.84	12.59
40	1.01	2.98	6.04	7.90	9.82	12.41
45	1.01	2.98	6.05	7.88	9.78	12.28
50	1.01	2.97	6.06	7.85	9.74	12.15
55	1.02	2.97	6.08	7.84	9.71	11.95
60	1.02	2.97	6.10	7.83	9.67	11.75
65	1.02	2.97	6.11	7.82	9.65	11.68
70	1.02	2.97	6.12	7.80	9.62	11.61
75	1.02	2.97	6.14	7.79	9.59	11.50
80	1.02	2.97	6.17	7.78	9.55	11.39
85	1.02	2.97	6.20	7.77	9.52	11.27
90	1.02	2.96	6.24	7.75	9.49	11.15
95	1.02	2.96	6.28	7.74	9.46	11.03

Buffer set 06

Merck ready-to-use buffer solutions

°C	pH		
0	4.68	6.98	9.46
5	4.68	6.95	9.40
10	4.67	6.92	9.33
15	4.67	6.90	9.28
20	4.66	6.88	9.22
25	4.66	6.86	9.18
30	4.66	6.86	9.14
35	4.66	6.85	9.10
40	4.67	6.84	9.07
45	4.68	6.84	9.04
50	4.68	6.84	9.01
55	4.69	6.84	8.99
60	4.70	6.84	8.96
65	4.71*	6.84	8.95
70	4.72*	6.84	8.93
75	4.74*	6.85	8.91
80	4.75*	6.86	8.89
85	4.77*	6.87	8.87
90	4.79*	6.88	8.85
95	4.81*	6.89	8.83

* Values to DIN 19 267
(not defined by Merck)

Buffer set 07

Ciba (94)

Nominal value: 2.06, 4.00, 7.00, 10.00

°C	pH			
0	2.04	4.00	7.10	10.30
5	2.09	4.02	7.08	10.21
10	2.07	4.00	7.05	10.14
15	2.08	4.00	7.02	10.06
20	2.09	4.01	6.98	9.99
25	2.08	4.02	6.98	9.95
30	2.06	4.00	6.96	9.89
35	2.06	4.01	6.95	9.85
40	2.07	4.02	6.94	9.81
45	2.06	4.03	6.93	9.77
50	2.06	4.04	6.93	9.73
55	2.05	4.05	6.91	9.68
60	2.08	4.10	6.93	9.66
65	2.07 ₅	4.10 ₅	6.92 ₅	9.61 ₅
70	2.07	4.11	6.92	9.57
75	2.04 ₅	4.13 ₅	6.92 ₅	9.54 ₅
80	2.02	4.15	6.93	9.52
85	2.03	4.17 ₅	6.95	9.47 ₅
90	2.04	4.20	6.97	9.43
95	2.05*	4.22 ₅ *	6.99*	9.38 ₅ *

 * Extrapolated
₅ Interpolated

Buffer set 10

Mettler-Toledo (USA)

°C	pH		
0	4.00	7.12	10.32
5	4.00	7.09	10.25
10	4.00	7.06	10.18
15	4.00	7.04	10.12
20	4.00	7.02	10.06
25	4.00	7.00	10.01
30	4.01	6.99	9.97
35	4.02	6.98	9.93
40	4.03	6.98	9.89
45	4.04	6.97	9.86
50	4.06	6.97	9.83
55	4.06*	6.97*	9.83*
60	4.06*	6.97*	9.83*
65	4.06*	6.97*	9.83*
70	4.06*	6.97*	9.83*
75	4.06*	6.97*	9.83*
80	4.06*	6.97*	9.83*
85	4.06*	6.97*	9.83*
90	4.06*	6.97*	9.83*
95	4.06*	6.97*	9.83*

* Extrapolated

Glossary

Buffer set	Contains selected buffer solutions which can be used for automatic calibration with the Knick Calimatic [®] . The buffer set must be selected prior to the first calibration.
Buffer solution	Solution with an exactly defined pH value for calibrating a pH meter.
cal	Key for activating the Calibration level.
Cal timer	Counts the time passed since the last calibration.
Calibration	Adjustment of the pH meter to the current electrode characteristics. Zero and slope are adjusted.
Calibration buffer set	See buffer set.
Calibration level	On the Calibration level the meter is adjusted for the connected electrode (calibration). You can conduct either a one or a two-point calibration.
Calibration record	Printout of all relevant data of the last calibration for documentation to GLP. Start printout by pressing cal and print .
Calimatic[®]	Automatic buffer recognition. Prior to first calibration, the used buffer set must be activated once on the Parameter level. The patented Calimatic [®] then automatically recognizes the buffer solution used during calibration.
Combination electrode	Combination of glass and reference electrode in one body.
diag	Key for activating the Diagnostics level.
Diagnostics level	Display of criteria for Sensoface [®] display, all relevant electrode data, electrode statistics and activation of Fullcheck [®] device self test.

Diagnostics record	Printout of criteria for Sensoface [®] display, all relevant electrode data, electrode statistics and results of Fullcheck [®] device self test for documentation to GLP. Start printout by pressing diag and print .
Electrode slope	Specified in mV/pH. It is different for each electrode and changes with age and wear.
Electrode statistics	The electrode statistics provide the electrode data of the last three calibrations and the first calibration.
Electrode zero point	Voltage output by a pH electrode at pH 7 (for deviating nominal zero point at correspondingly different pH value). It is different for each electrode and changes with age and wear.
enter	Key for confirming entries.
First calibration	During first calibration, the electrode data are stored as reference values for electrode statistics.
GLP	Good Laboratory Practice: Guidelines for performance and documentation of measurements in the laboratory.
Isothermal potential	The isothermal potential is the potential at which the calibration curves for different temperatures intersect. Ideally, this is at 0 mV.
Knick Drycheck[®]	Knick Drycheck [®] monitors the electrodes and alerts for dry out, glass breakage and defective connections.
Knick Fullcheck[®]	Device self test, checks complete measuring circuitry, signal processing, memories, display, and keypad.
meas	This key allows return to measuring mode from all other levels.
Measuring mode	When no function level is activated, the meter is in measuring mode. The two displays indicate the respectively assigned variable.

Nominal electrode zero point	<p>Nominal value of electrode zero point. For commercial electrodes, the nominal electrode zero point is at pH 7.</p> <p>Special electrodes can have a different zero point. If you want to use such an electrode, your meter must be equipped with Option 346.</p>
Nominal electrode slope	<p>Nominal value of electrode slope. For commercial electrodes, the nominal slope is 59.2 mV/pH at 25 °C.</p> <p>Special electrodes, such as Pfaudler or Antimony probes, can have a different slope. If you want to use such an electrode, your meter must be equipped with Option 346.</p>
One-point calibration	<p>Calibration that only takes account of the electrode zero point. The old slope value is retained. Only one buffer solution is required for a one-point calibration.</p>
par	<p>Key for activating the Parameter level.</p>
Parameter level	<p>The Parameter level is divided into two submenus. VIEW menu and EDIT menu. The VIEW menu allows to display all parameters without editing them. The EDIT menu allows to view and edit all parameters.</p>
Parameter record	<p>Printout of all stored parameter settings for documentation to GLP. Start printout by pressing par and print.</p>
pH electrode	<p>A pH electrode system consists of a glass and a reference electrode. If they are combined in one body, they are referred to as combination electrode.</p>
Print interval timer	<p>The print interval timer allows to preset an interval for printout of currently measured values with time and date.</p>
Response time	<p>Time from the start of a calibration step to the stabilization of the electrode potential.</p>

Sensoface[®]

Automatic electrode monitoring. The Sensoface[®] display provides information on the electrode condition. It evaluates zero point, slope, response time, impedance and dry-out of the electrode and the cal timer count.

Slope

See Electrode slope.

Trueline[®]

The Trueline[®] recorder output provides a pH-calibrated analog output signal, without disturbing voltage steps.

Two-point calibration

Calibration that takes account of zero point and slope of the electrode. Two buffer solutions are required for two-point calibration.

Zero point

See electrode zero point.

Index

B

Buffer set 14
Buffer tables 49

C

Calibration error messages 42
Calibration level 18
Calibration record 20
Calibration timer
 Setting 15
Commissioning 6
Connection
 Double platinum electrode 7
 Electrode 7
 Mains 6
 Polarization current 7

D

Device self-test 27
Diagnostics
 Diagnostics level 21
 Electrode Data menu 21
 Knick Fullcheck menu 21
 Sensoface menu 21, 22
Diagnostics record 29
Displaymatic 13
Double platinum electrode 7

E

EDIT menu 10
Electrode connection 6
Electrode Data menu 25
Electrode statistics 25
Error messages 41
 List of 34

F

First calibration
 Activation 15

I

Interface cable 32

K

Keypad 3

L

Lab printer, ZU 0244
 Standard settings 32

M

Mains supply 6
Measuring mode 9
Menu structure 5

N

Nominal electrode slope (setting for
Option 346) 13
Nominal electrode zero (setting for
Option 346) 13

O

One-point calibration 19
Operation
 Meter design 2
Option 346 13

P

Package contents 1
Parameter record 12
Parameter setting
 Activation 10
 EDIT menu 10
 Example 11
 VIEW menu 10
Polarization current 7
Print interval timer 16
Printer, ZU 0244
 Standard settings 32
Printing
 Calibration record 20
 Diagnostics record 29
 Measured values 9
 Parameter record 12
Product line 45

R

Recorder output 30
 Setting 15
Remote interface
 Cable 32
 Commands 32

- Parameters 31
- Pin assignment 31
- Printer 32
- RS 232 interface 31

S

- Safety information III
- Sensoface 5
- Sensoface menu 21, 22
- Sensor monitoring 5
- Setting
 - Remote interface 16

- Short check (at power-on) 8
- Short description 1
- Specifications 46
- Standby mode 8

T

- Trueline recorder output 30
- Two-point calibration 19

V

- VIEW menu 10